

MOTORS WITH POWER OVER 1000 W

NK SERIES - Non reversible

WATT: 3100 / CONSUMPTION: 2800 NI/1"

Data sheet
NK100D

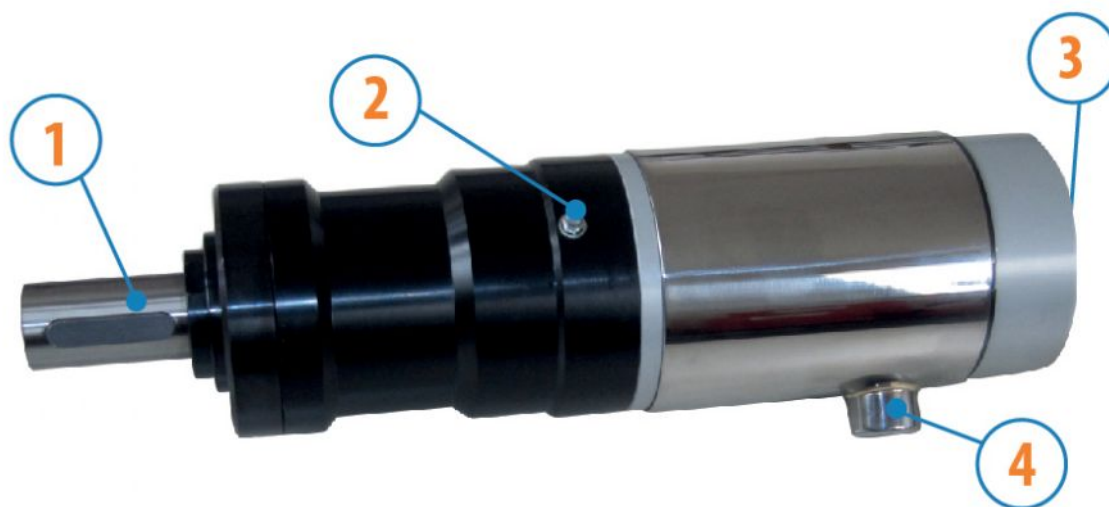

1. Cylindrical keyed shaft
2. Grease gun
3. Air inlet
4. Air exhaust

Technical specification

Right rotation - Model	NK100D
Right rotation - Code	8711261
Speed rpm - No-load	100
Speed rpm - at Max Power	70
Torque Nm - at Max Power	406
Torque Nm - Stall Torque	990

Form features

The normal delivery condition:
cylindrical shaft and body as shown in the photo.

Optional:

Shaft

- threaded - indication / AF (left rotation excluded - subject to checks for reversible)

- conical - indication / AC

- with collets - indication / AP

Characteristic curves

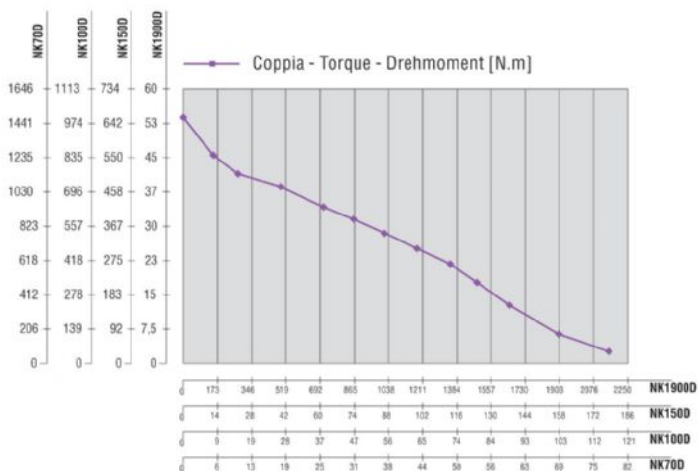

MOTORS WITH POWER OVER 1000 W

NK SERIES - Non reversible

WATT: 3100 / CONSUMPTION: 2800 NI/1"

Data sheet
NK100D

Permissible radial and axial loads

Model	Code	Fr (N)	Fa (N)	Co (N)
NK100D	8711261	11000	8000	54000

Overall dimensions

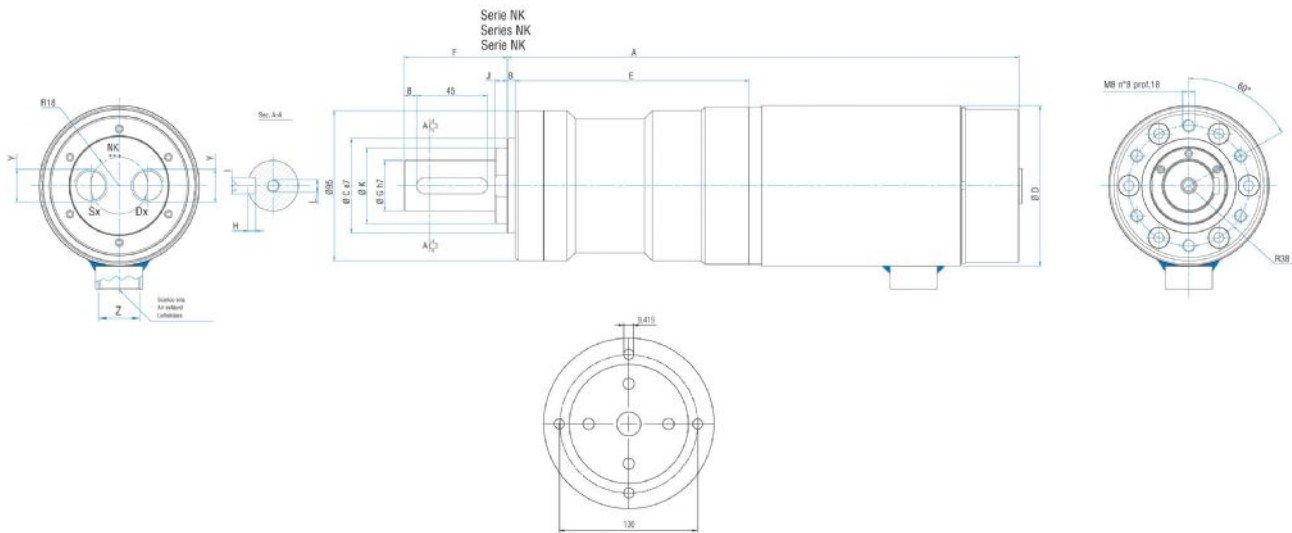

Flange disponibili per alcuni modelli.
Flanges available for some models.
Flansche erhältlich für einige Modelle.

Model	Code	A	B	C	D	E	F	G	H	I	J	K	L	Y	Z
NK100D	8711261	331,8	5	60	101,6	148,3	65,5	32	5	10	7,5	48	M8	1/2"	3/4"